

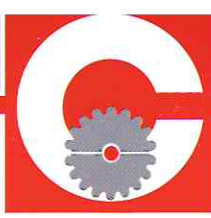

CHIARAVALLI®

GROUP

SpA



The MANUFACTURER distributor

MOTORS AND GEARBOXES

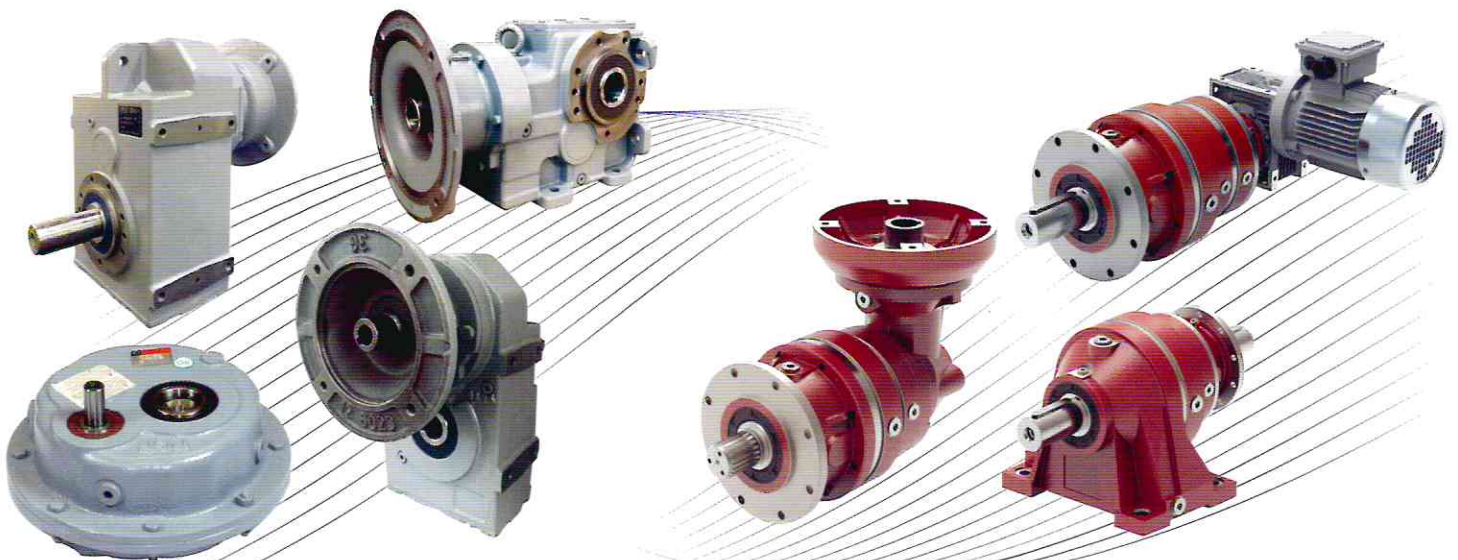
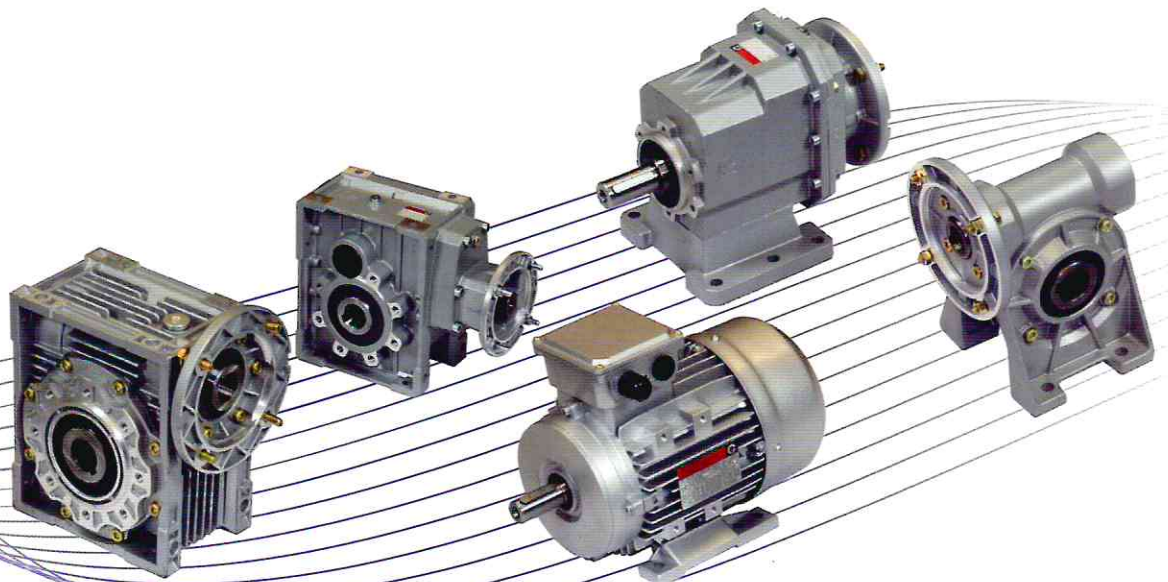

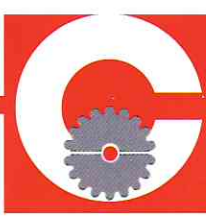

GEARBOXES RANGE



WORM GEARBOXES CH LINE ALUMINIUM FRAME

SIZE	03	04	05	06	07	08							
SHAFT Ø	14 mm	18 mm	25 mm	25 mm	30 mm	35 mm							
TORQUE	18 Nm	37 Nm	73 Nm	155 Nm	276 Nm	340 Nm							

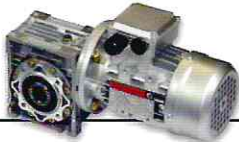

WORM GEARBOXES CHM LINE ALUMINIUM FRAME

SIZE	25	30	40	50	63	75	90	110	130	150			
SHAFT Ø	11 mm	14 mm	18 mm	25 mm	25 mm	28 mm	35 mm	42 mm	45 mm	50 mm			
TORQUE	14 Nm	20 Nm	42 Nm	80 Nm	165 Nm	232 Nm	431 Nm	710 Nm	980 Nm	992 Nm			



BEVEL GEARBOXES CHO LINE ALUMINIUM FRAME

SIZE	52/53	62/63	72/73	82/83									
SHAFT Ø	25 mm	25 mm	30 mm	35 mm									
TORQUE	130 Nm	200 Nm	350 Nm	500 Nm									



HELICAL GEARBOXES CHC LINE ALUMINIUM FRAME

SIZE	16/20	25	30	35/40									
SHAFT Ø	16/20 mm	25 mm	30 mm	35/40 mm									
TORQUE	120 Nm	200 Nm	300 Nm	500 Nm									



BEVEL GEARBOXES CH-G K LINE CAST IRON FRAME

SIZE	35/390	40/390	50/390	60/390	70/390	90/390	100/390						
SHAFT Ø	35 mm	40/45 mm	50 mm	60 mm	70 mm	90 mm	100 mm						
TORQUE	600 Nm	850 Nm	1800 Nm	3500 Nm	5000 Nm	8000 Nm	13000 Nm						



HELICAL GEARBOXES CH-G A/F LINE CAST IRON FRAME

SIZE	352/353	402/403	502/503	602/603	702/703	902/903							
SHAFT Ø	35 mm	40 mm	50 mm	60 mm	70 mm	90 mm							
TORQUE	500 Nm	850 Nm	1800 Nm	3500 Nm	5000 Nm	8000 Nm							



PARALEL AXIS GEARBOXES CH-G D/M LINE CAST IRON FRAME

SIZE	352/353	402/403	502/503	602/603									
SHAFT Ø	35 mm	40 mm	50 mm	60 mm									
TORQUE	500 Nm	850 Nm	1800 Nm	3500 Nm									



SHAFT MOUNTED GEARBOXES CHA LINE CAST IRON FRAME

SIZE	30/30	35/35	40/40	40/45	45/45	45/50	45/55	50/50	50/55	50/60	60/60	60/70	70/70
SHAFT Ø	30 mm	35 mm	40 mm	45 mm	45 mm	50 mm	55 mm	50 mm	55 mm	60 mm	60 mm	70 mm	70 mm
TORQUE	170 Nm	420 Nm	920 Nm	920 Nm	1400 Nm	1400 Nm	1400 Nm	2300 Nm	2300 Nm	2300 Nm	3500 Nm	3500 Nm	4900 Nm



PLANETARY GEARBOXES CAST IRON FRAME CHPL/CHPLB SERIES

SIZE	1000	1600	2500	5000	7000	10000	16000	18000	25000	30000	35000		
SHAFT Ø	42 mm	42 mm	65 mm	65 mm	80 mm	90 mm	100 mm	100 mm	110 mm	110 mm	120 mm		
TORQUE	1000 Nm	1600 Nm	2500 Nm	5000 Nm	7000 Nm	10000 Nm	16000 Nm	18000 Nm	25000 Nm	30000 Nm	35000 Nm		

ATTENTION: the performance and dimensional data are only indicative, please look at the catalogues



The MANUFACTURER distributor

PLANETARY GEARBOXES

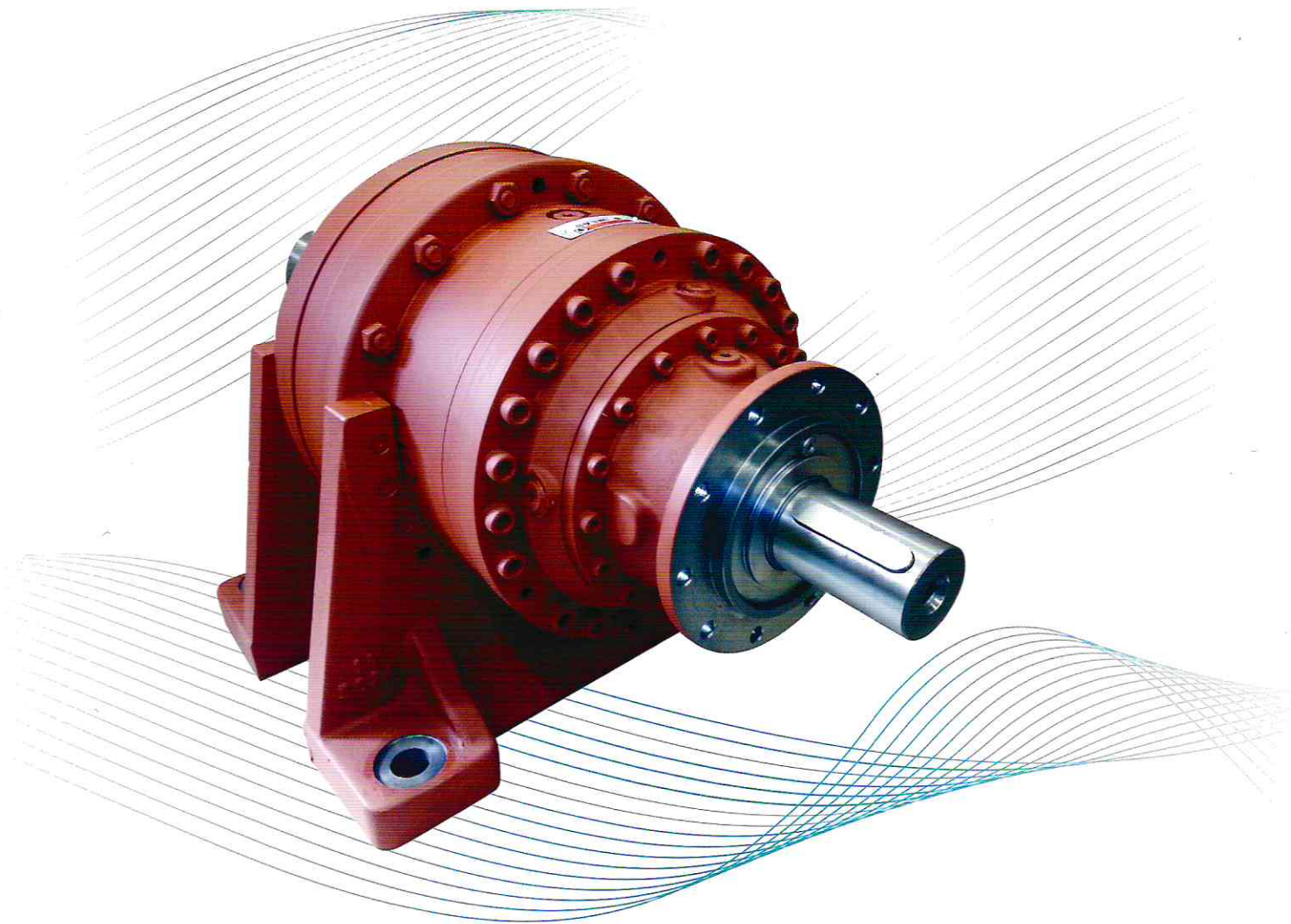

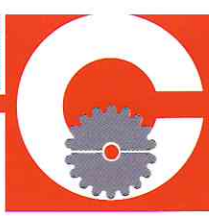

PLANETARY GEARBOXES

AXIAL PLANETARY GEARBOX WITH OUTPUT HOLLOW SPLINE SHAFT



AXIAL PLANETARY GEARBOX WITH DOUBLE INPUT OUTPUT SHAFT

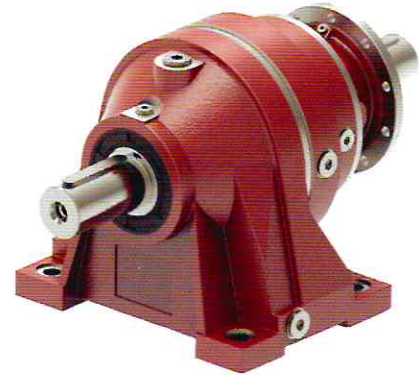

RIGHT ANGLE PLANETARY GEARBOX WITH SPLINE OUTPUT SHAFT



AXIAL PLANETARY GEARBOX WITH FEET AND DOUBLE INPUT OUTPUT FLANGE



RIGHT ANGLE PLANETARY GEARBOX WITH MOTOR OIL EXTENSION TANK

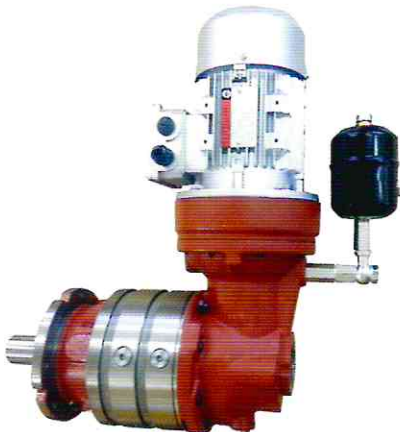

AXIAL PLANETARY GEARBOX WITH HORBITAL MOTOR



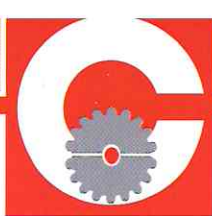

The MANUFACTURER distributor

MECHANICAL WORM SCREW JACKS

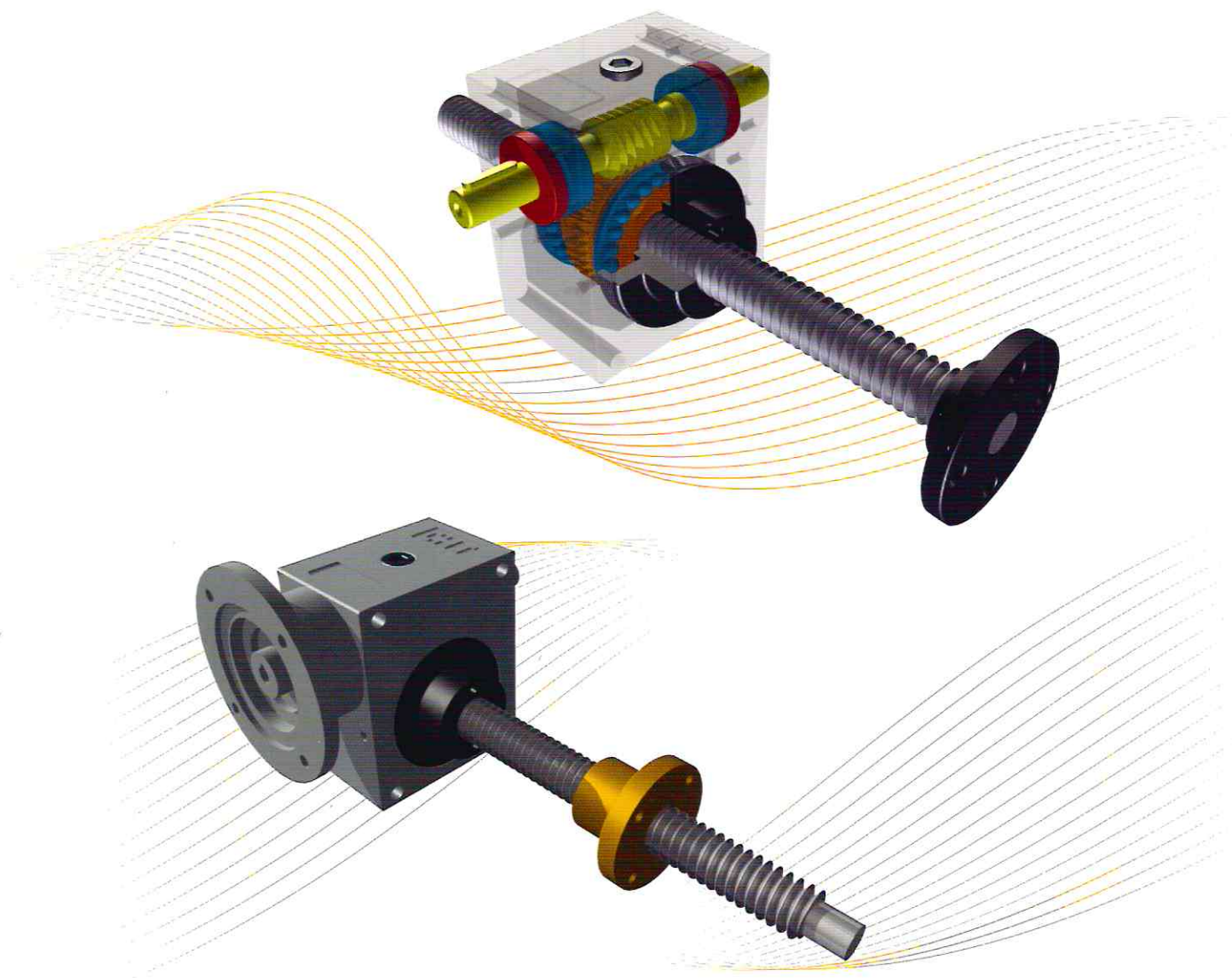

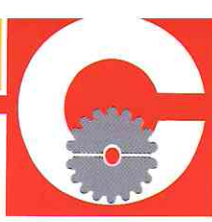

MECHANICAL WORM SCREW JACKS

SECTIONED JACK

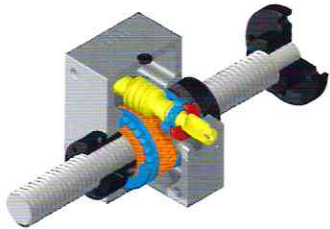

SERIES CHS1 TS or RS - load kg 500

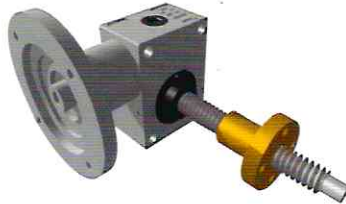

SERIES CHS2 TS or RS - load kg 1.000



SERIES CHS3 TS or RS - load kg 2.500



SERIES CHS4 TS or RS - load kg 5.000



SERIES CHS5 TS or RS - load kg 10.000



SERIES CHS6 TS or RS - load kg 15.000

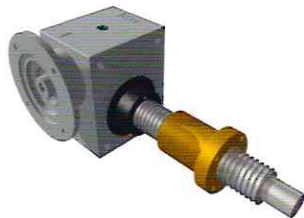

SERIES CHS7 TS or RS - load kg 20.000

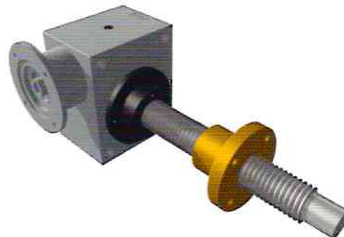

SERIES CHS8 TS or RS - load kg 25.000

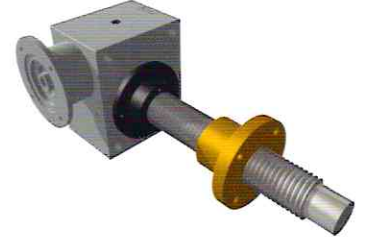

SERIES CHS9 TS or RS - load kg 30.000



SERIES CHS10 TS or RS - load kg 40.000



SERIES CHS12 TS or RS - load kg 60.000



SERIES CHS14 TS or RS - load kg 80.000

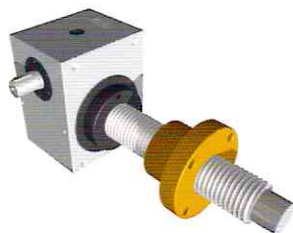

SERIES CHS16 TS or RS - load kg 100.000



SPECIAL VERSIONS AVAILABLE

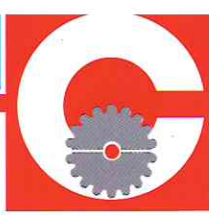

The MANUFACTURER distributor

LA NUOVA LINEA **CH EVOLUTION**
L'EVOLUZIONE DEL RIDUTTORE
SECONDO CHIARAVALLI



- STRUTTURA MONOLITICA
- COSTRUZIONE ROBUSTA
- RIDUZIONI DEI COSTI
- RIDUZIONE DEL NUMERO DEGLI ACCESSORI
- ASSOLUTA INTERCAMBIABILITÀ
CON LE VECCHIE VERSIONI
- PLUG AND PLAY



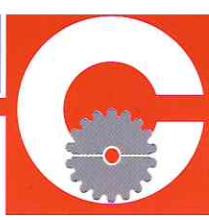

The MANUFACTURER distributor

CLAMPING ELEMENTS **RCK**[®] BRAND

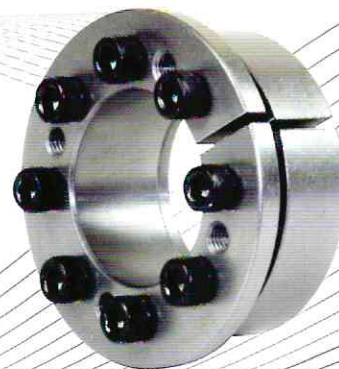
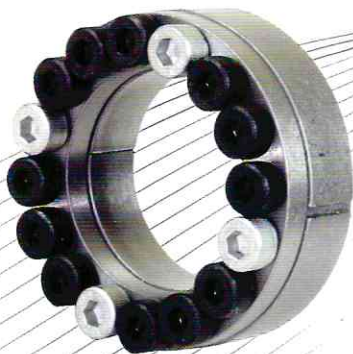
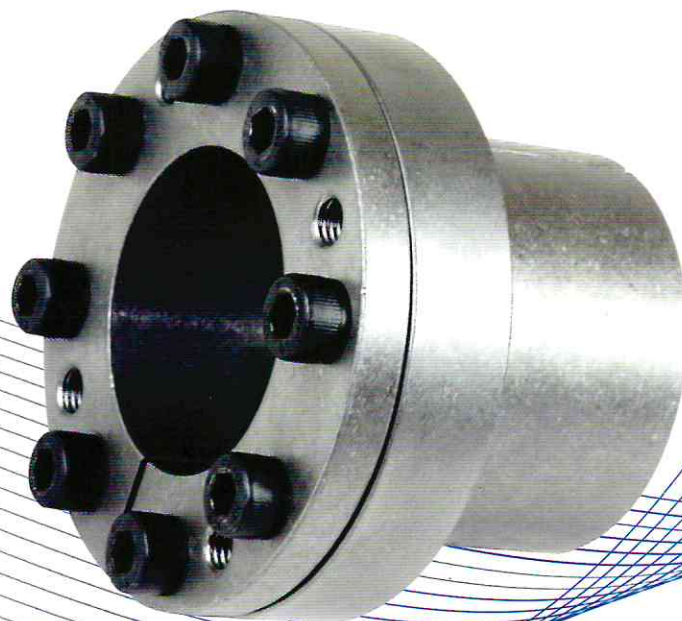

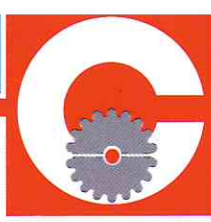

CLAMPING ELEMENTS

SELF CENTRING RCK 11



SELF CENTRING RCK 13



SELF CENTRING RCK 15



SELF CENTRING RCK 16



SELF CENTRING RCK 19



NOT SELF CENTRING RCK 40



NOT SELF CENTRING RCK 45

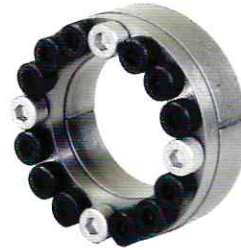

SELF CENTRING RCK 55



SELF CENTRING RCK 60



SELF CENTRING RCK 61



SELF CENTRING RCK 70-71
(RCK 71 eventually with spacer)



SELF CENTRING RCK 80



RCK 95



NOT SELF CENTRING RCK 50

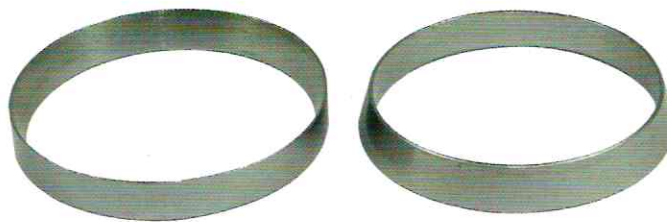

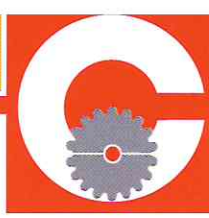

The MANUFACTURER distributor

TAPER BUSHES RCB[®] BRAND



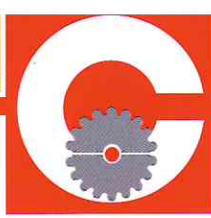

TAPER BUSHES RCB® BRAND

TAPER BUSHES TL GREY CAST IRON

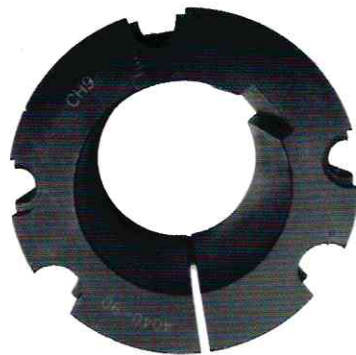

BUSHES TYPE

SERIES 1008 - 1108 - 1210
SERIES 1215 - 1610 - 1615
SERIES 2012 - 2517
SERIES 3020 - 3030
SERIES 3525 - 3535
SERIES 4030 - 4040 - 4535
SERIES 4545 - 5040 - 5050

ADAPTORS FOR TAPER BUSHES GREY CAST IRON



TYPE ADAPTORS

ARC 1008
ARC 1210
ARC 1610
ARC 1615
ARC 2517
ARC 3030
ARC 3535
ARC 4040

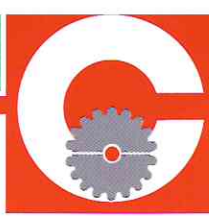

The MANUFACTURER distributor

FLEXIBLE COUPLINGS GIFLEX®

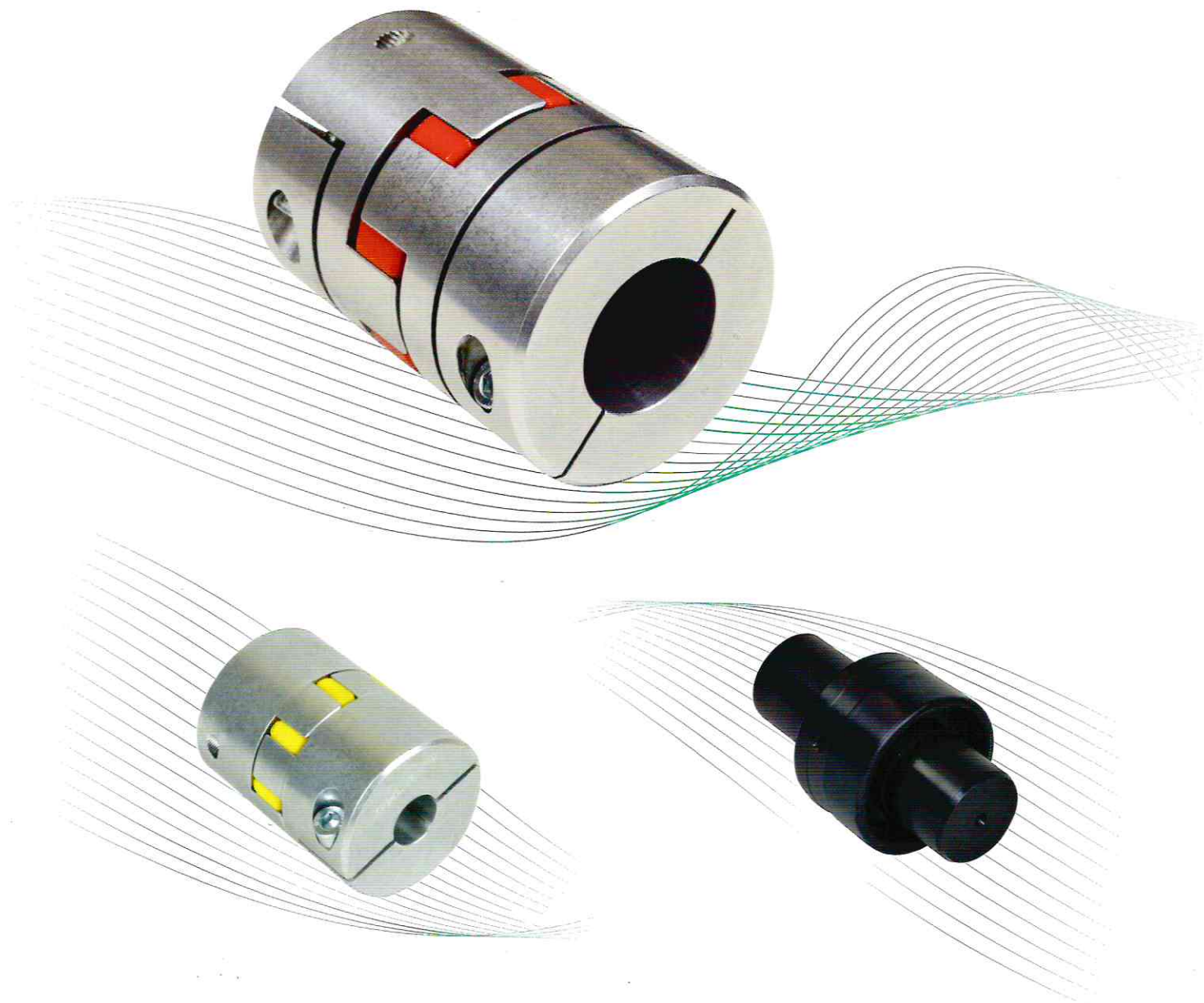

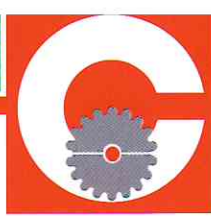

FLEXIBLE COUPLINGS GIFLEX®

SERIES GE-T ALUMINIUM COUPLING



SERIES GE-T CAST IRON COUPLING



SERIES GE-T TL COUPLING



SERIES GE-T SG COUPLING
WITH SIMPLE CUT



SERIES GE-T SG COUPLING
WITH DOUBLE CUT



SERIES GF COUPLING
WITH POLYAMIDE SLEEVE



SERIES GFA COUPLING
WITH STEEL SLEEVE



SERIES GFAS COUPLING
WITH STEEL BELL



GIFLEX® FBX COUPLING
WITH NYLON SLEEVE





The MANUFACTURER distributor



CHIARAVALLI MASTER DISTRIBUTOR





URB BEARINGS

DEEP GROVE ball bearings



SELF ALIGNING ball bearings



ANGULAR CONTACT ball bearings



CYLINDRICAL roller bearings



TAPERED roller bearings

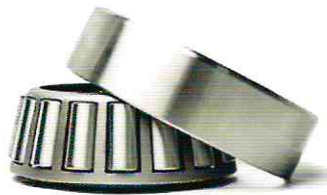

SPHERICAL roller bearings



THRUST ball bearings



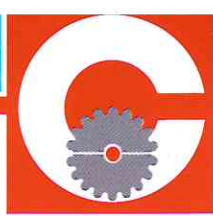

The MANUFACTURER distributor

PILLOW BLOCKS FSB® BRAND



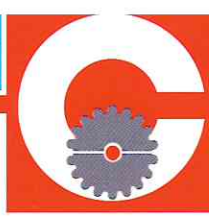

PILLOW BLOCKS FSB® BRAND

UPC 200



UCFC 200



UCF 200



UCPA 200



UCFL 200



PP 200



UCFA 200



PF 200



UCT 200



PFL 200



P 200 THERMOPLASTIC



F 200 THERMOPLASTIC

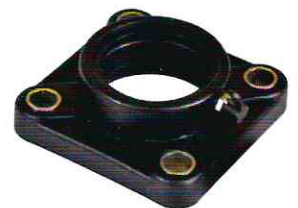

FL 200 THERMOPLASTIC



RCM-AS STANDARD SHAFT



RCM-AL SPECIAL LONG SHAFT



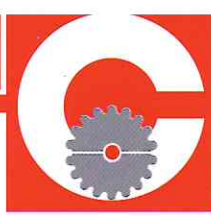

The MANUFACTURER distributor

PLATEWHEELS



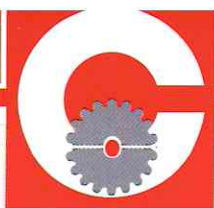

PLATEWHEELS

ISO SIMPLE PLATEWHEELS
ASA SIMPLE PLATEWHEELS



ISO DOUBLE PLATEWHEELS
ASA DOUBLE PLATEWHEELS



ISO TRIPLE PLATEWHEELS
ASA TRIPLE PLATEWHEELS



DOUBLE PLATEWHEELS FOR
TWO SIMPLE CHAINS TL



PLATEWHEELS FOR
CONVEYORS AND ELEVATORS



DOUBLE PLATEWHEELS FOR
TWO SIMPLE CHAINS



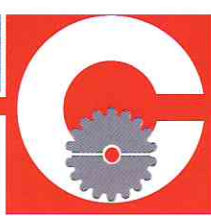

The MANUFACTURER distributor

TIMING PULLEYS

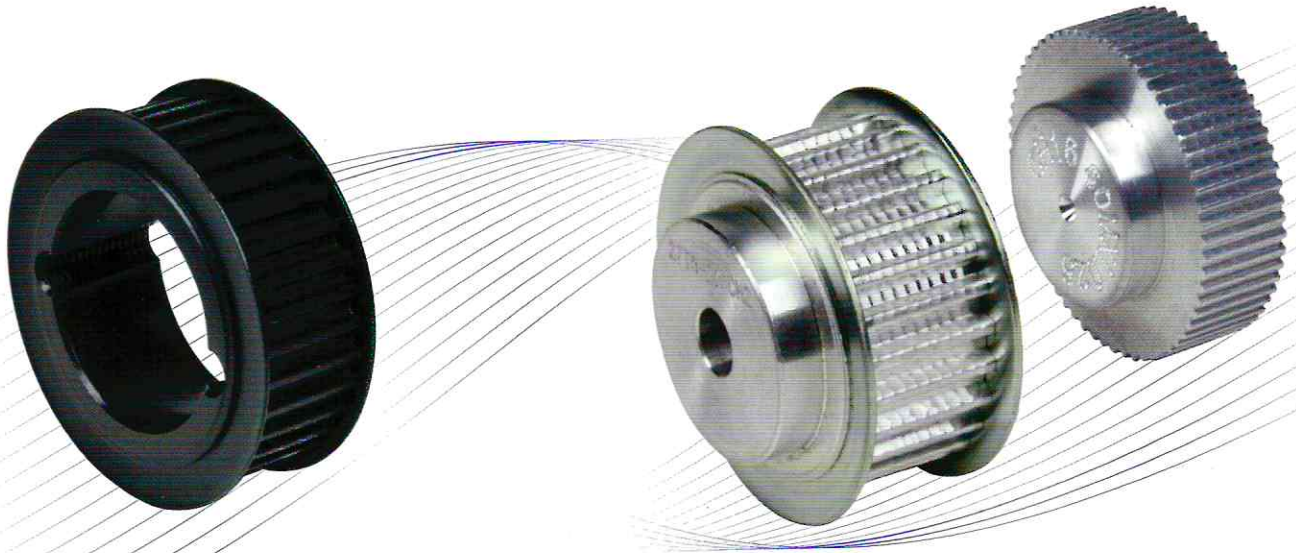
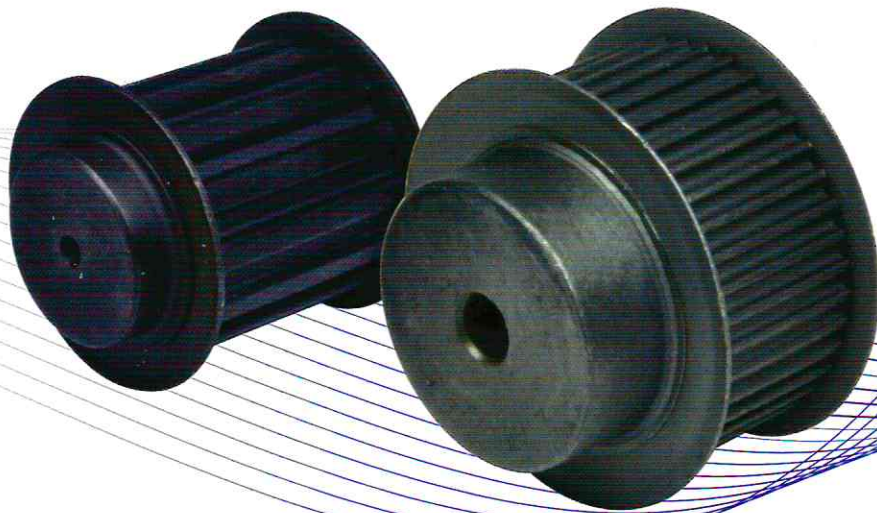

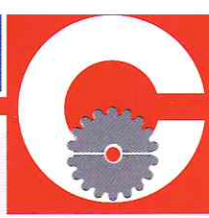

TIMING PULLEYS

TIMING PULLEYS WITH PILOT BORE

FOR POSITIVE BELTS

MXL TYPE
XL TYPE
L TYPE
H TYPE
XH TYPE
XXH TYPE

EXPORT TIMING PULLEYS

FOR POSITIVE BELTS

XL TYPE
L TYPE
H TYPE

TAPER LOCK® TIMING PULLEYS

FOR POSITIVE BELTS

L TYPE
H TYPE

HTD® TIMING PULLEYS WITH PILOT BORE

PILOT BORE

3M TYPE
5M TYPE
8M TYPE
14M TYPE

HTD® TAPER LOCK® TIMING PULLEYS

5M TYPE
8M TYPE
14M TYPE

GT® TIMING PULLEYS WITH PILOT BORE

PILOT BORE

3MR TYPE
5MR TYPE

POLY CHAIN® GT® TIMING PULLEYS

TAPER LOCK® PHOSPHATED

8M TYPE
14M TYPE

"T" METRIC TIMING PULLEYS

T 2,5 TYPE
T 5 TYPE
T 10 TYPE

"CT" METRIC TIMING PULLEYS

CT 5 TYPE
CT 10 TYPE

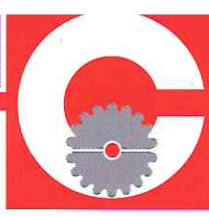

The MANUFACTURER distributor

TIMING BARS ■ FLANGES FOR PULLEYS ■ CLAMPING BELTS PLATES

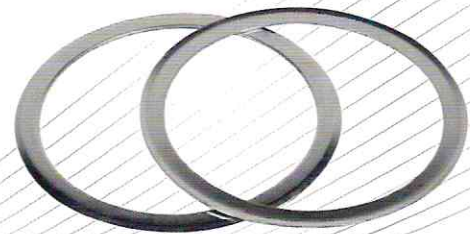
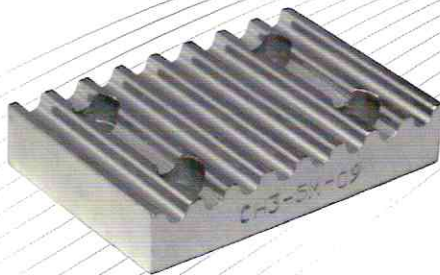
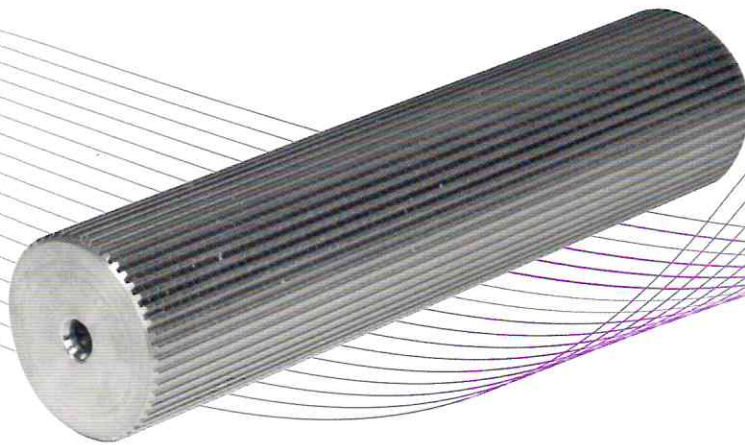

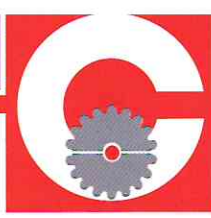

TIMING BARS ■ FLANGES FOR PULLEYS ■ CLAMPING BELTS PLATES

POLY CHAIN GT®
TIMING BARS 8M - 14M



TIMING BARS
FOR POSITIVE BELTS MXL - XL - L

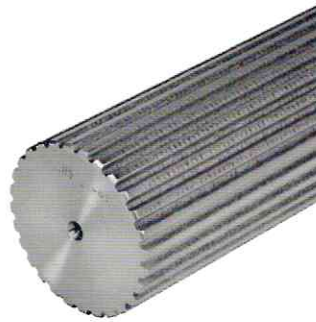

HTD® TIMING BARS 5M - 8M

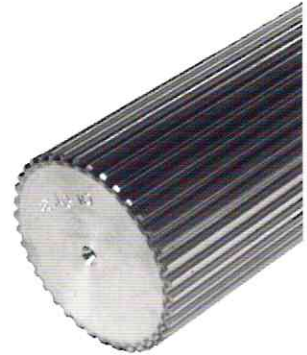

GT® TIMING BARS 3MR - 5MR



METRIC TIMING BARS
FOR METRIC BELTS "T" 2.5 - 5 - 10



METRIC TIMING BARS "CT"
FOR METRIC BELTS "AT" 5 - 10



FLANGES FOR PULLEYS

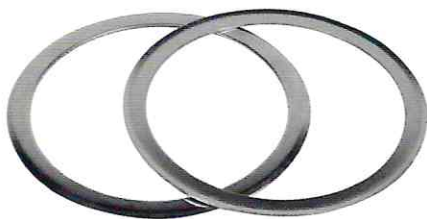

Thickness: 0,5 | 1 | 1,5 | 2,5 mm

PLATE FOR TIMING BELT
POWERGRIP® POSITIVE
POWERGRIP® HTD®



PLATE FOR TIMING BELT
METRIC PITCH "T"
METRIC PITCH "AT"



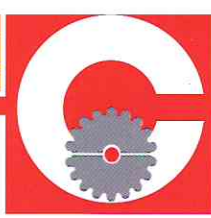

The MANUFACTURER distributor

V-BELT PULLEYS

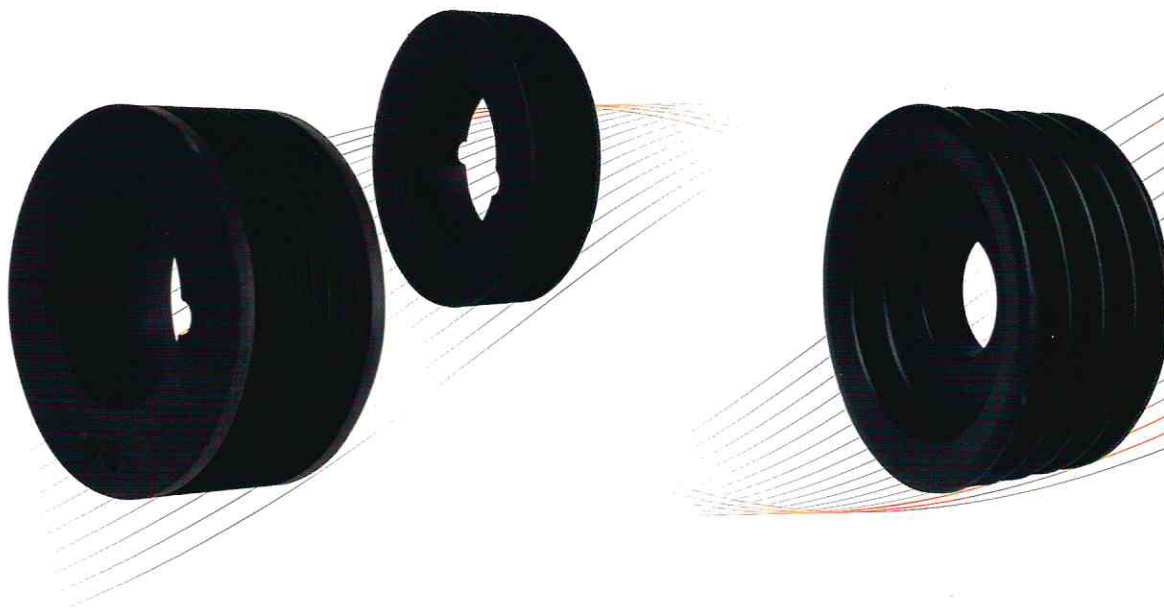



V-BELT PULLEYS

V-BELT PULLEYS FOR TAPER BUSHES

TAPER BUSHES

SPZ TYPE
SECTION SPZ
SPA TYPE
SPB TYPE
SPC TYPE

Material Cast Iron

V-BELT PULLEYS PILOT BORE

SOLID HUB

SPA TYPE
SPB TYPE
SPC TYPE

Material Cast Iron

V-BELT PULLEYS FOR LOCKING DEVICES

LOCKING DEVICES

SPA TYPE
SPB TYPE
SPC TYPE

Material Cast Iron

ADJUSTABLE V-BELT PULLEY PRB TYPE

PRB TYPE

PRB 93
PRB 108
PRB 120
PRB 138
PRB 160
PRB 180
PRB 200
Material Cast Iron G20 UNI 5007

V-BELT PULLEYS PPV-J MICRO V

N. GROOVES

8
12
16

Material Cast Iron

V-BELT PULLEYS PPV-L MICRO V

N. GROOVES

8
12
16

Material Cast Iron

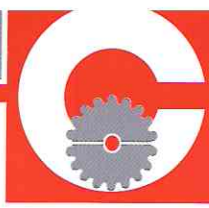

The MANUFACTURER distributor

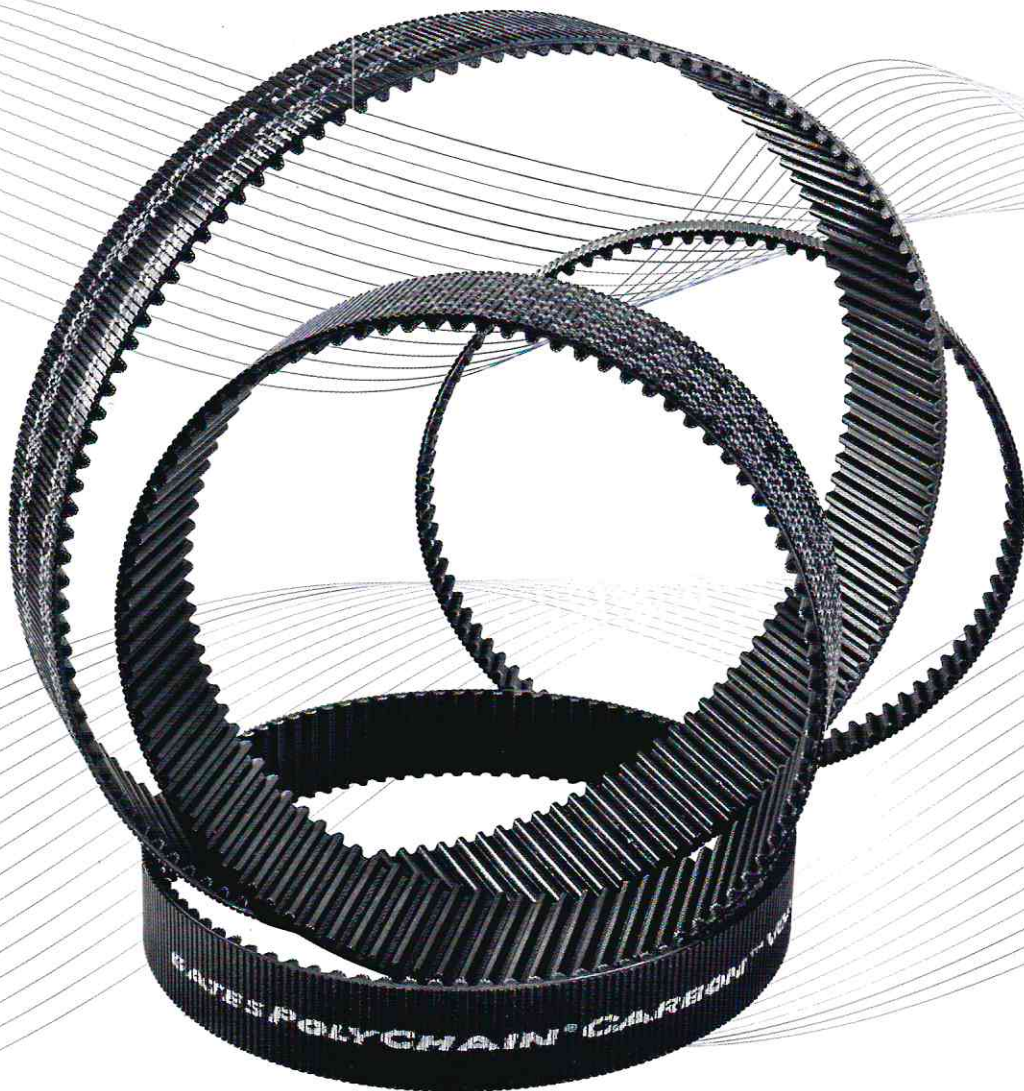



Gates BELTS

QUAD-POWER® 4

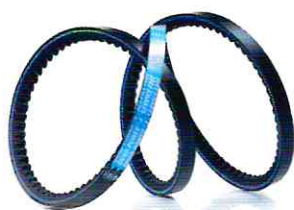

DELTA CLASSIC™



DELTA NARROW™



PREDATOR®



TRAPEZOIDAL POLYFLEX®
TRAPEZOIDAL POLYFLEX® JB™

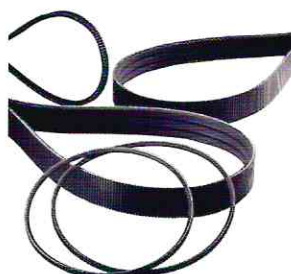

POWER GRIP® XL-L-H-XH



POWER GRIP® GTX
POWER GRIP® GT3
POWER GRIP® HTD®



POLY CHAIN® CARBON VOLT



SYNCHRONOUS TWIN POWER®



POLYURETHANE BELTS

SYNCHRO -POWER®

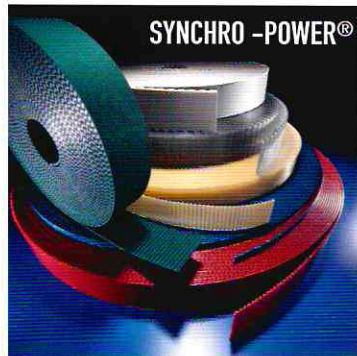

SUPER FLEX™



SYNCHRO -POWER®



SYNCHRO -POWER®

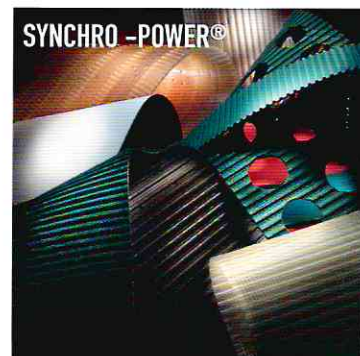

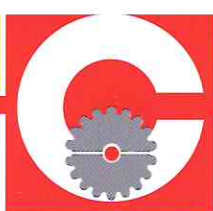

The MANUFACTURER distributor

SPROCKETS



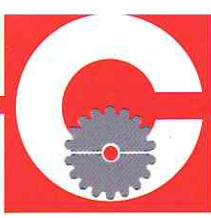

SPROCKETS

ISO SIMPLE CHAIN SPROCKETS
ASA SIMPLE CHAIN SPROCKETS



ISO DOUBLE CHAIN SPROCKETS
ASA DOUBLE CHAIN SPROCKETS



ISO TRIPLE CHAIN SPROCKETS
ASA TRIPLE CHAIN SPROCKETS



STAINLESS STEEL CHAIN SPROCKETS



FINISHED BORE HARDENED SPROCKETS



TAPER LOCK® CHAIN SPROCKETS



CAST IRON CHAIN SPROCKETS



CHAIN SPROCKETS FOR CONVEYORS
AND ELEVATORS



IDLER SPROCKETS



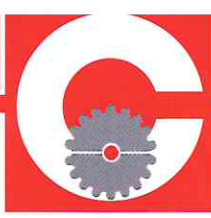

The MANUFACTURER distributor

CHAINS

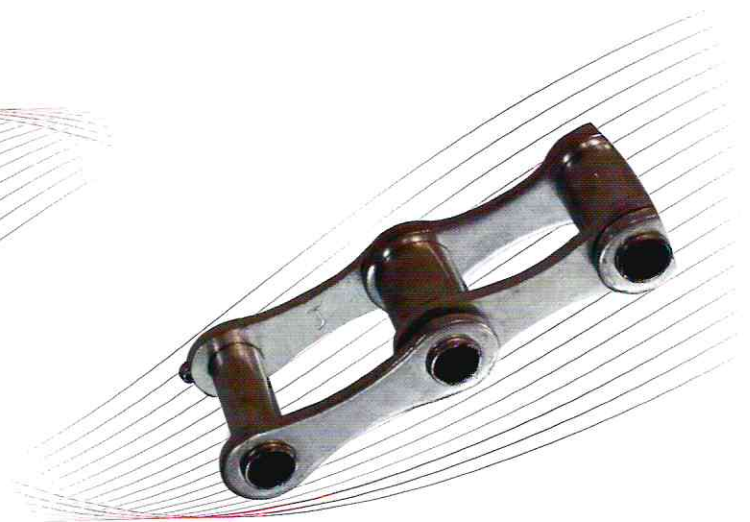
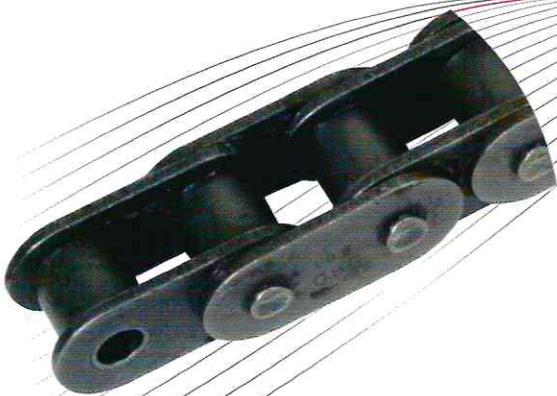
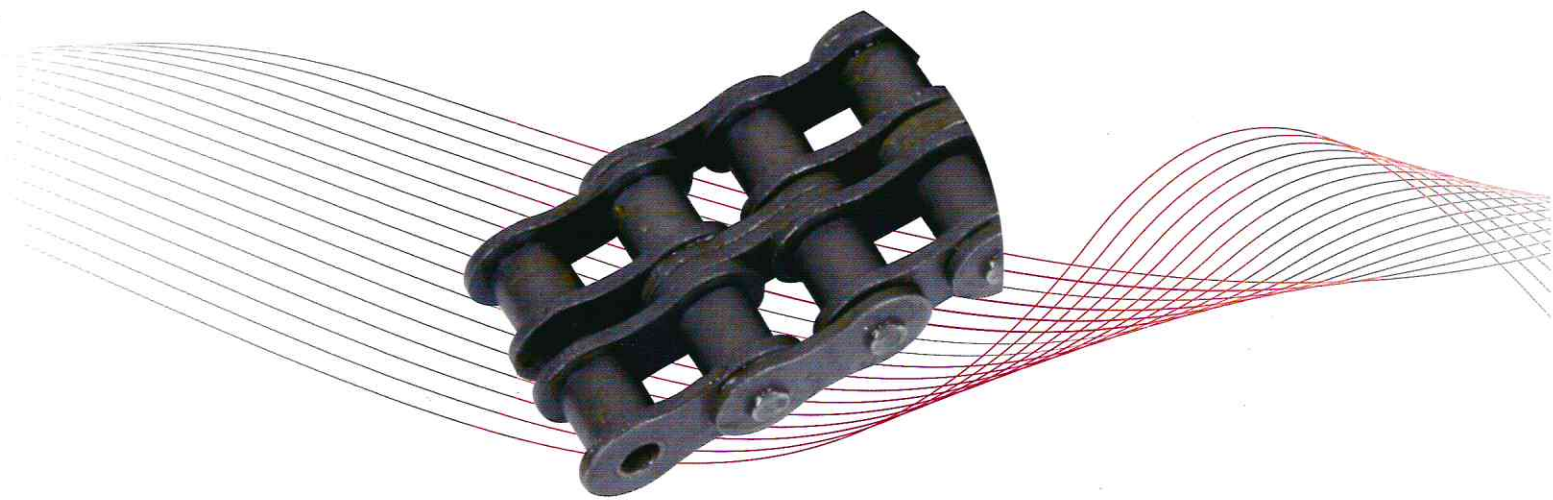

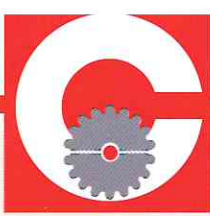

CHAINS

ROLLER CHAINS **TPM**[®]
- EUROPEAN SERIES



ROLLER CHAINS **QRC**[®]
- EUROPEAN SERIES
- AMERICAN SERIES

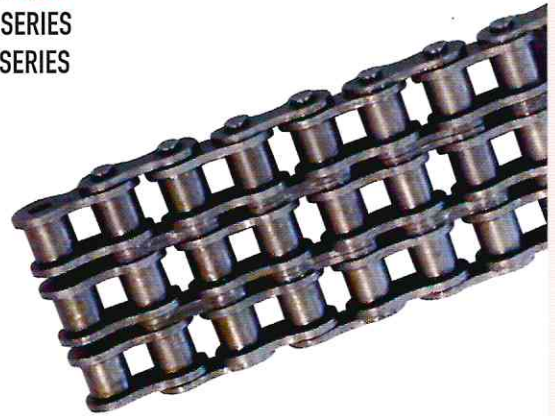

CHAIN PLATE STRAIGHT **QRC**[®]

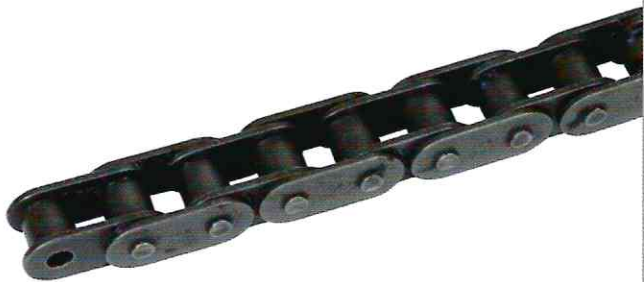

CHAIN PINS DRILLED **QRC**[®]



ROLLER CHAINS **RCX**[®]



TRANSPORT CHAINS **CRT**[®]



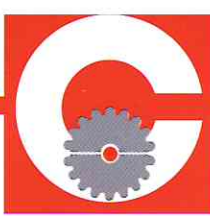

The MANUFACTURER distributor

TENSIONERS MADE IN ITALY

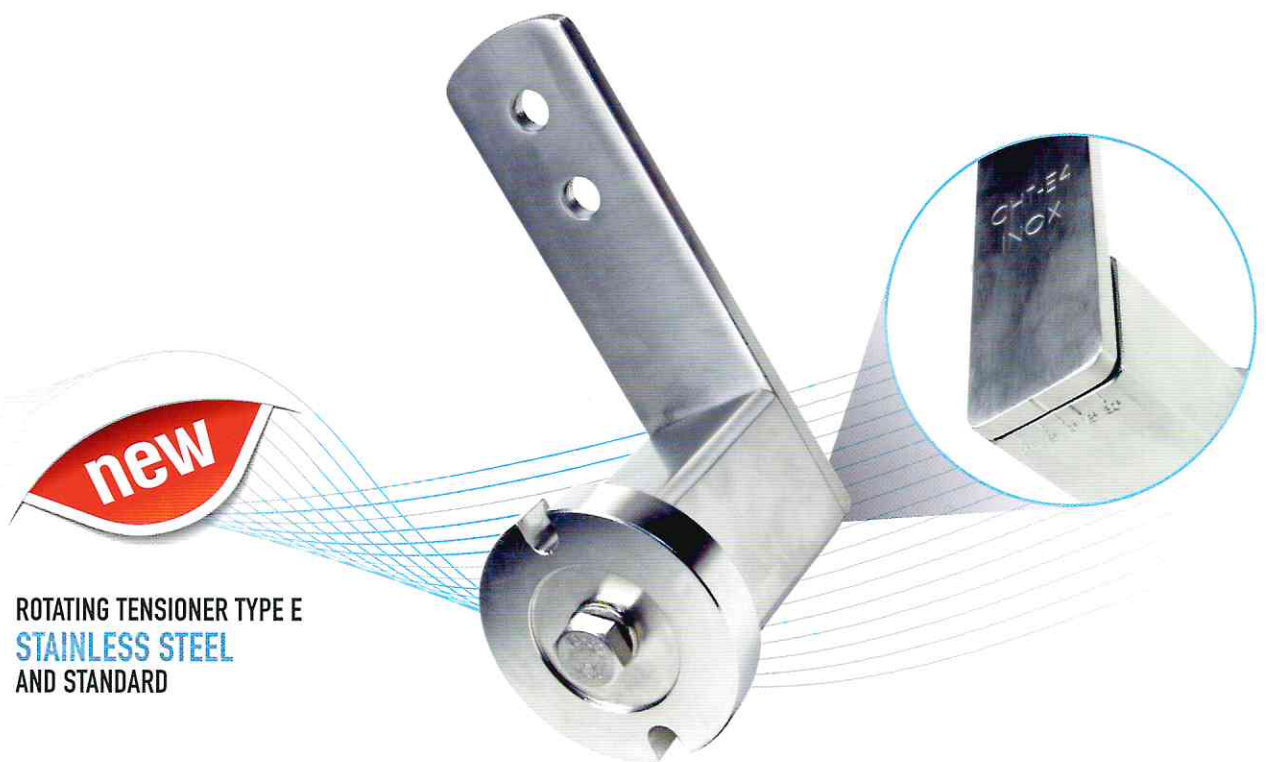

ROTATING TENSIONER TYPE E
STAINLESS STEEL
AND STANDARD

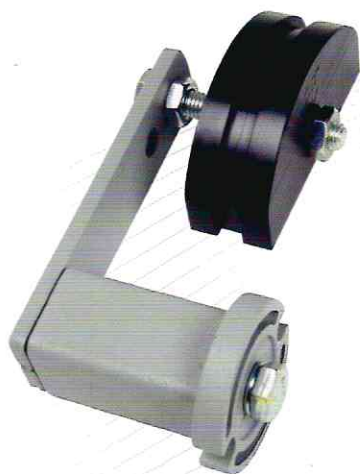

ROTATING TENSIONER
CHT-EGE

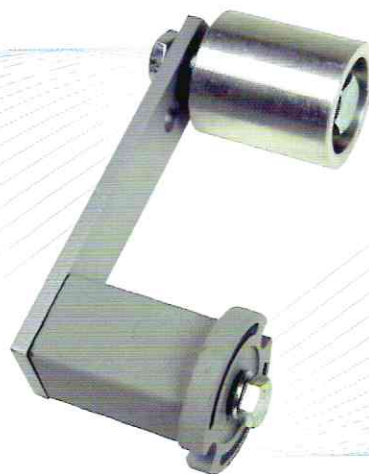

ROTATING TENSIONER
CHT-ERU



ROTATING TENSIONER
CHT-ER

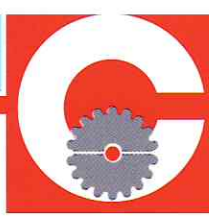

TENSIONERS MADE IN ITALY

ROTATING TENSIONER
CHT-T



ROTATING BELT TENSIONER
CHT-TRU



ROTATING CHAIN TENSIONER
CHT-TR



ROTATING CHAIN TENSIONER
CHT-TGE



LINEAR TENSIONER
CHT-L



LINEAR TENSIONER
CHT-AS



LINEAR CHAIN TENSIONER
CHT-ASR



LINEAR BELT TENSIONER
CHT-ASRU



LINEAR CHAIN TENSIONER
CHT-ASFR TN



LINEAR CHAIN TENSIONER
CHT-ASGE



LINEAR CHAIN TENSIONER
CHT-ASGO



LINEAR CHAIN TENSIONER
CHT-ASGA



LINEAR CHAIN TENSIONER
CHT-LP



LINEAR CHAIN TENSIONER
CHT-PAE PAO



BELT TENSIONER ROLLER
CHT-RU



SLIDING BLOCK CHAIN TENSIONER
CHT1GA CHT1GE CHT1GO CHT1GE-P
ASGAIR ASGEIR ASGOIR

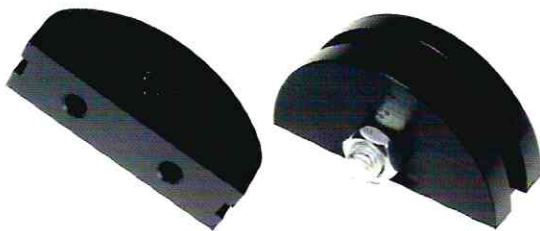

SPROCKETS KIT - STAINLESS STEEL VERSION AVAILABLE



CHT-RU



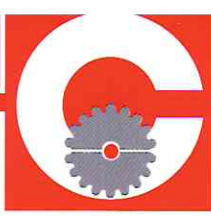

The MANUFACTURER distributor

STRAIGHT SPUR GEARS AND RACKS

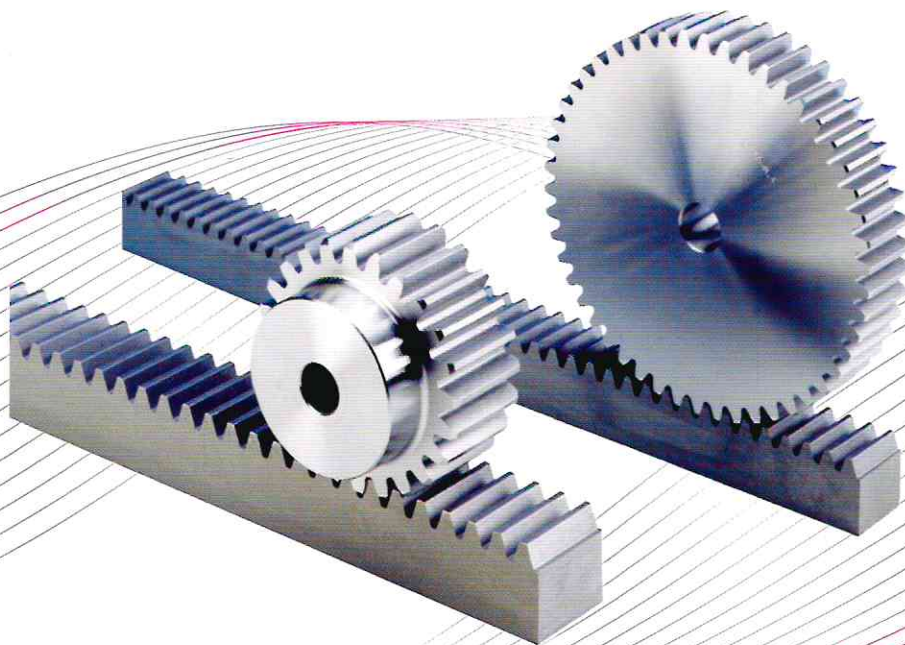

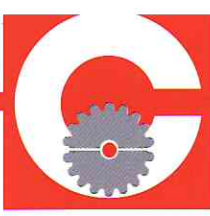

STRAIGHT SPUR GEARS AND RACKS

SPUR GEARS WITHOUT LATERAL HUB



MOD. 1 | 1,5 | 2 | 2,5 | 3 | 4 | 5 | 6

SPUR GEARS WITH LATERAL HUB



MOD. 1 | 1,5 | 2 | 2,5 | 3 | 4 | 5 | 6 | 8 | 10

RACKS

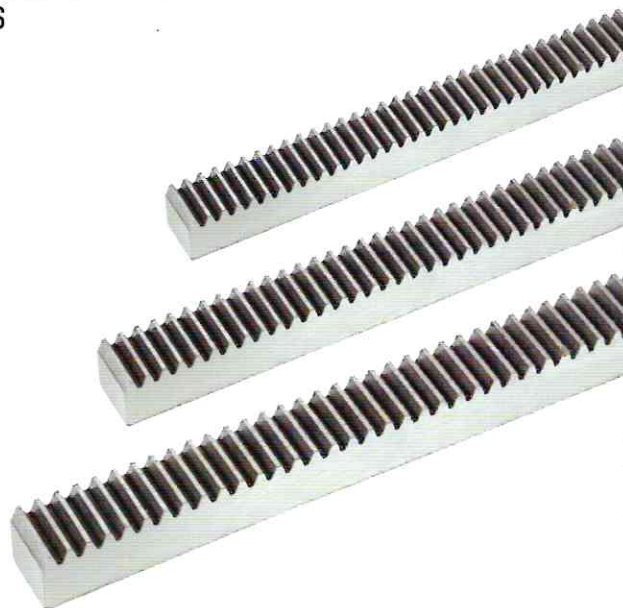

MOD. 1 | 1,5 | 2 | 2,5 | 3 | 4 | 5 | 6 | 8 | 10

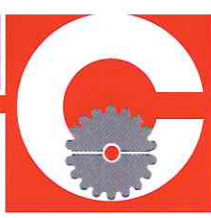

The MANUFACTURER distributor

COLLARS AND WASHERS

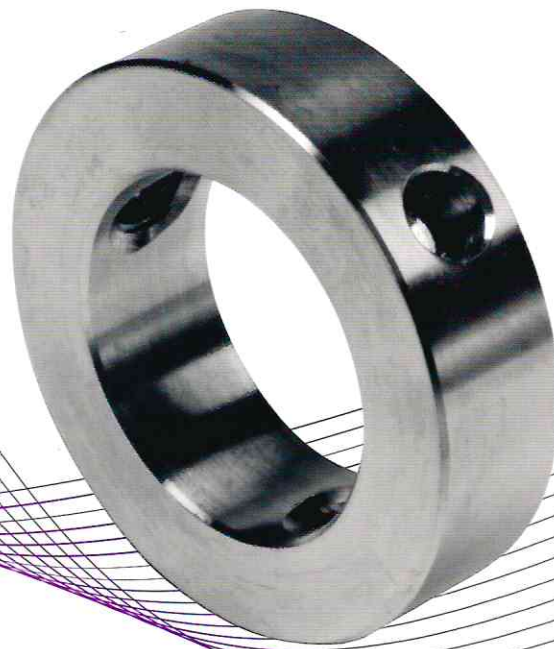

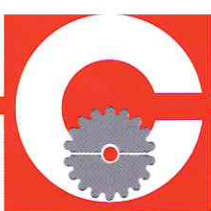

COLLARS AND WASHERS

SERIES C-ABU INOX



SERIES C-ABU GALVANISED



SERIES C-ABU PHOSPHATED



SERIES C-AB GALVANISED



SERIES C-AB PHOSPHATED



SERIES C-ADB GALVANISED



SERIES C-ADB PHOSPHATED



SERIES C-RGS GALVANISED



SERIES C-RGS PHOSPHATED



SERIES C-RS PHOSPHATED



SERIES C-RC GALVANISED



SERIES C-RC PHOSPHATED



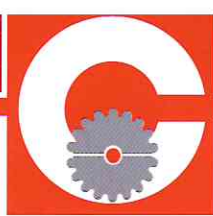

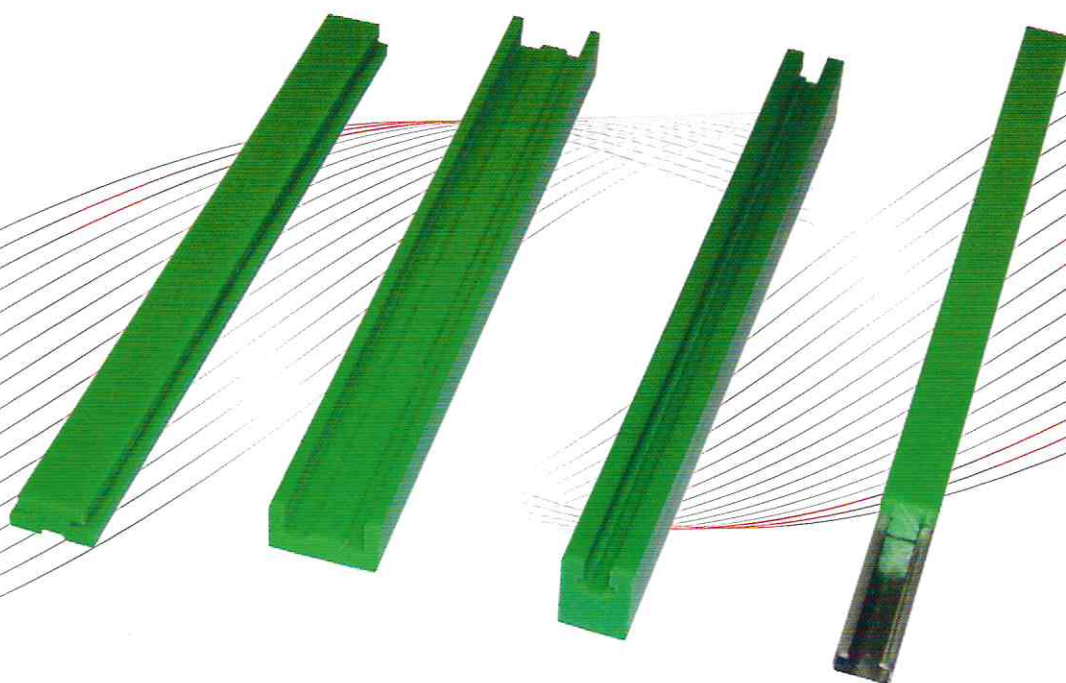

The MANUFACTURER distributor

POLYETHYLENE **GUIDE RAILS** and METAL STEEL **HOLDER**



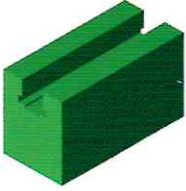
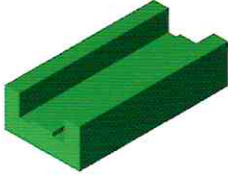

POLYETHYLENE **GUIDE RAILS** and METAL **STEEL HOLDER**

<p>PROFILE BL (For Chain) Steel holder not included</p> 	<p>PROFILE BLC (For Chain) Steel holder not included</p> 	<p>PROFILE E1 (For Chain)</p> 	<p>PROFILE E1C (For Chain) Steel holder not included</p> 
<p>PROFILE E2 (For Chain)</p> 	<p>PROFILE T1 (For Chain)</p> 	<p>PROFILE T1C (For Chain) Steel holder not included</p> 	<p>PROFILE T2 (For Chain)</p> 
<p>PROFILE T2C (For Chain) Steel holder not included</p> 	<p>PROFILE T3 (For Chain)</p> 	<p>PROFILE U (For Chain)</p> 	
<p>PROFILE PC (For Belts) Steel holder not included</p> 	<p>PROFILE SF (F) (For Belts)</p> 	<p>PROFILE SF (X) (FC) (For Belts) Steel holder not included</p> 	<p>PROFILE V (For Belts)</p> 
<p>PROFILE VC (For Belts) Steel holder not included</p> 	<p>METAL STEEL HOLDER C 3 5 9 (For Belts)</p> 	<p>METAL STEEL HOLDER C 10 11 (For Belts)</p> 	

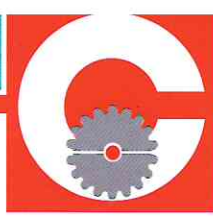

The MANUFACTURER distributor

O.E.M. COMPONENTS

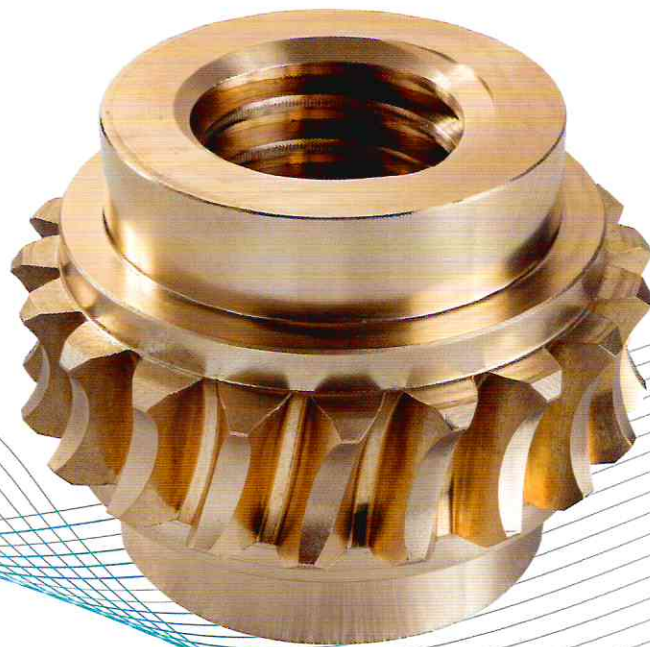

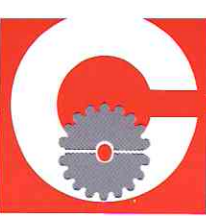

O.E.M. COMPONENTS

